



Sistema DW - ECO 1.0 316

Chimenea modular metálica para evacuación de humos y gases de los productos de la combustión de doble pared fabricada en acero inoxidable interior y exterior.

MATERIAL

Pared Interior: AISI 316L

Pared Exterior: AISI 304

ACABADO EXTERIOR

Brillante

Colores RAL (consulta página 14 para acabados especiales)

Exterior galvanizado -15% (sólo tramos rectos y desviaciones)

Gama **DW-SCHWARZ** con pintura exterior negra (RAL 9005). Se indica precio de la gama en Ø150 mm. Para el resto de diámetros consulte precios y disponibilidad.

AISLAMIENTO

Lana de roca rígida de alta densidad (120kg/m³)

ESPEORES (mm)

Pared interior: 0,4 mm

Aislamiento: 25 mm

Pared exterior: 0,4 mm

DIÁMETROS DISPONIBLES (mm)

Ø80 a Ø200

SISTEMA DE UNIÓN

Conexión macho-hembra con **abrazadera de unión sencilla**

NIVEL DE ESTANQUEIDAD

Txxx - N1: Sin necesidad de junta

T120 - H1: Incluir junta de condensación (DW2526CØ)*.

T200 - H1: Incluir junta de estanqueidad (DW2526Ø)*.



Para incluir la junta de condensación (T<120°C) preinstalada de fábrica, sustituir el código del sistema 909 por B11*.
Para incluir la junta de estanqueidad (T<200°C) preinstalada de fábrica, sustituir el código del sistema 909 por B01*.
Excepto terminales



APLICACIONES

- Calderas de condensación
- Calderas y estufas de combustibles sólidos
- Fuegos bajos
- Hornos
- Cocinas de leña



CARACTERÍSTICAS

- Temperatura de trabajo hasta 600°C
- **Soldadura TIG/LÁSER** en continuo en todas las piezas
- **Abrazadera de unión incluida (excepto terminales)**
- Posibilidad de **corte de módulos rectos a medida** en obra (ver instrucciones de corte página 53)
- **Para condensación es necesaria la junta de condensación (DW2526C) en las uniones y una pendiente mínima de 3° en tramos horizontales (T<120°C)**

CERTIFICADO CE

0036 CPR 9174 030

0036 CPR 9174 044

CLASIFICACIONES CE (UNE-EN 1856-1)

T600 - N1 - D - V3 - L50040 - G(70)

T450 - N1 - D - V3 - L50040 - G(60)

T400 - N1 - W - V2 - L50040 - O(30)

T200 - H1 - W - V2 - L50040 - O(20) (con junta de estanqueidad DW2526)

T120 - H1 - W - V2 - L50040 - O(00) (con junta de condensación DW2526C)



Módulo recto 1.000 mm



Módulo recto 500 mm



Módulo recto 250 mm



Módulo recto 250 mm con desagüe lateral



Módulo recto regulable 400 - 560 mm

Ø 80	909-DWECO130080	144€	909-DWECO140080	102€	909-DWECO150080	75€	909-DWECO15D0080	103€	909-DWECO5440080	144€
Ø 80 SCHWARZ	B09-DWECO130080	187€	B09-DWECO140080	132€	B09-DWECO150080	97€	B09-DWECO15D0080	134€	B09-DWECO5440080	187€
Ø 100	909-DWECO130100	149€	909-DWECO140100	110€	909-DWECO150100	78€	909-DWECO15D0100	112€	909-DWECO5440100	149€
Ø 100 SCHWARZ	B09-DWECO130100	193€	B09-DWECO140100	143€	B09-DWECO150100	102€	B09-DWECO15D0100	147€	B09-DWECO5440100	193€
Ø 130	909-DWECO130130	154€	909-DWECO140130	112€	909-DWECO150130	80€	909-DWECO15D0130	119€	909-DWECO5440130	154€
Ø 130 SCHWARZ	B09-DWECO130130	201€	B09-DWECO140130	147€	B09-DWECO150130	103€	B09-DWECO15D0130	154€	B09-DWECO5440130	201€
Ø 150	909-DWECO130150	173€	909-DWECO140150	127€	909-DWECO150150	87€	909-DWECO15D0150	128€	909-DWECO5440150	172€
Ø 150 SCHWARZ	B09-DWECO130150	227€	B09-DWECO140150	165€	B09-DWECO150150	112€	B09-DWECO15D0150	166€	B09-DWECO5440150	226€
Ø 180	909-DWECO130180	208€	909-DWECO140180	149€	909-DWECO150180	101€	909-DWECO15D0180	146€	909-DWECO5440180	201€
Ø 200	909-DWECO130200	245€	909-DWECO140200	174€	909-DWECO150200	117€	909-DWECO15D0200	162€	909-DWECO5440200	230€



Módulo recto regulable 560 - 920 mm



Codo 15°



Codo 30°



Codo 45°



Codo 60°

Ø 80	909-DWECO5450080	216€	909-DWECO160080	102€	909-DWECO170080	102€	909-DWECO180080	102€	909-DWECO840080	127€
Ø 80 SCHWARZ	B09-DWECO5450080	284€	B09-DWECO160080	132€	B09-DWECO170080	132€	B09-DWECO180080	132€	B09-DWECO840080	165€
Ø 100	909-DWECO5450100	224€	909-DWECO160100	110€	909-DWECO170100	110€	909-DWECO180100	110€	909-DWECO840100	131€
Ø 100 SCHWARZ	B09-DWECO5450100	290€	B09-DWECO160100	143€	B09-DWECO170100	143€	B09-DWECO180100	143€	B09-DWECO840100	170€
Ø 130	909-DWECO5450130	230€	909-DWECO160130	112€	909-DWECO170130	112€	909-DWECO180130	112€	909-DWECO840130	138€
Ø 130 SCHWARZ	B09-DWECO5450130	300€	B09-DWECO160130	147€	B09-DWECO170130	147€	B09-DWECO180130	147€	B09-DWECO840130	179€
Ø 150	909-DWECO5450150	256€	909-DWECO160150	125€	909-DWECO170150	125€	909-DWECO180150	125€	909-DWECO840150	151€
Ø 150 SCHWARZ	B09-DWECO5450150	333€	B09-DWECO160150	163€	B09-DWECO170150	163€	B09-DWECO180150	163€	B09-DWECO840150	197€
Ø 180	909-DWECO5450180	301€	909-DWECO160180	144€	909-DWECO170180	144€	909-DWECO180180	144€	909-DWECO840180	175€
Ø 200	909-DWECO5450200	346€	909-DWECO160200	168€	909-DWECO170200	168€	909-DWECO180200	168€	909-DWECO840200	202€



Codo 87°



Codo 90°



Te 87°



Te 90°



Te 135°

Ø 80	909-DWECO640080	147€	909-DWECO600080	147€	909-DWECO110080	250€	909-DWECO3170080	215€	909-DWECO120080	306€
Ø 80 SCHWARZ	B09-DWECO640080	190€	B09-DWECO600080	190€	B09-DWECO110080	327€	B09-DWECO3170080	280€	B09-DWECO120080	397€
Ø 100	909-DWECO640100	154€	909-DWECO600100	154€	909-DWECO110100	263€	909-DWECO3170100	223€	909-DWECO120100	318€
Ø 100 SCHWARZ	B09-DWECO640100	201€	B09-DWECO600100	201€	B09-DWECO110100	341€	B09-DWECO3170100	289€	B09-DWECO120100	414€
Ø 130	909-DWECO640130	157€	909-DWECO600130	157€	909-DWECO110130	272€	909-DWECO3170130	229€	909-DWECO120130	330€
Ø 130 SCHWARZ	B09-DWECO640130	204€	B09-DWECO600130	204€	B09-DWECO110130	353€	B09-DWECO3170130	299€	B09-DWECO120130	430€
Ø 150	909-DWECO640150	179€	909-DWECO600150	179€	909-DWECO110150	302€	909-DWECO3170150	248€	909-DWECO120150	397€
Ø 150 SCHWARZ	B09-DWECO640150	232€	B09-DWECO600150	232€	B09-DWECO110150	393€	B09-DWECO3170150	322€	B09-DWECO120150	477€
Ø 180	909-DWECO640180	204€	909-DWECO600180	204€	909-DWECO110180	351€	909-DWECO3170180	292€	909-DWECO120180	428€
Ø 200	909-DWECO640200	238€	909-DWECO600200	238€	909-DWECO110200	409€	909-DWECO3170200	339€	909-DWECO120200	508€



Sistema DW - ECO 1.0 316



Te pellets
(Colector de hollín)



Colector de hollín



Colector de hollín aislado



Colector de hollín
con desagüe



Colector de hollín
con desagüe aislado

Ø 80	909-DWECO12970080	165€	909-DWECO5510080	38,82€	909-DWECO20330080	60€	909-DWECO440080	47,47€	909-DWECO14600080	77€
Ø 80 SCHWARZ	B09-DWECO12970080	214€	B09-DWECO5510080	50€	B09-DWECO20330080	78€	B09-DWECO440080	61€	B09-DWECO14600080	101€
Ø 100	909-DWECO12970100	170€	909-DWECO5510100	41,71€	909-DWECO20330100	70€	909-DWECO440100	48,91€	909-DWECO14600100	83€
Ø 100 SCHWARZ	B09-DWECO12970100	221€	B09-DWECO5510100	55€	B09-DWECO20330100	90€	B09-DWECO440100	63€	B09-DWECO14600100	108€
Ø 130	-	-	909-DWECO5510130	48,91€	909-DWECO20330130	78€	909-DWECO440130	59€	909-DWECO14600130	90€
Ø 130 SCHWARZ	-	-	B09-DWECO5510130	63€	B09-DWECO20330130	102€	B09-DWECO440130	77€	B09-DWECO14600130	118€
Ø 150	-	-	909-DWECO5510150	56€	909-DWECO20330150	88€	909-DWECO440150	68€	909-DWECO14600150	102€
Ø 150 SCHWARZ	-	-	B09-DWECO5510150	74€	B09-DWECO20330150	113€	B09-DWECO440150	89€	B09-DWECO14600150	132€
Ø 180	-	-	909-DWECO5510180	61€	909-DWECO20330180	101€	909-DWECO440180	72€	909-DWECO14600180	116€
Ø 200	-	-	909-DWECO5510200	70€	909-DWECO20330200	113€	909-DWECO440200	80€	909-DWECO14600200	129€



Colector de hollín
con desagüe lateral



Módulo de inspección
L=330 mm



Módulo temperatura
humos L=330 mm



Módulo de inspección
con tapa 40 Pa (N1)



Módulo de inspección
con tapa 200 Pa (P1)

Ø 80	909-DWECO10080	111€	909-DWECO5430080	125€	909-DWECO870080	508€	909-DWECO680080	200€	909-DWECO5490080	200€
Ø 80 SCHWARZ	B09-DWECO10080	146€	B09-DWECO5430080	163€	B09-DWECO870080	662€	B09-DWECO680080	259€	B09-DWECO5490080	259€
Ø 100	909-DWECO10100	119€	909-DWECO5430100	128€	909-DWECO870100	528€	909-DWECO680100	218€	909-DWECO5490100	218€
Ø 100 SCHWARZ	B09-DWECO10100	154€	B09-DWECO5430100	166€	B09-DWECO870100	686€	B09-DWECO680100	285€	B09-DWECO5490100	285€
Ø 130	909-DWECO10130	131€	909-DWECO5430130	131€	909-DWECO870130	546€	909-DWECO680130	229€	909-DWECO5490130	229€
Ø 130 SCHWARZ	B09-DWECO10130	170€	B09-DWECO5430130	170€	B09-DWECO870130	709€	B09-DWECO680130	299€	B09-DWECO5490130	299€
Ø 150	909-DWECO10150	142€	909-DWECO5430150	147€	909-DWECO870150	608€	909-DWECO680150	239€	909-DWECO5490150	239€
Ø 150 SCHWARZ	B09-DWECO10150	184€	B09-DWECO5430150	190€	B09-DWECO870150	792€	B09-DWECO680150	312€	B09-DWECO5490150	312€
Ø 180	909-DWECO10180	155€	909-DWECO5430180	172€	909-DWECO870180	694€	909-DWECO680180	250€	909-DWECO5490180	250€
Ø 200	909-DWECO10200	168€	909-DWECO5430200	197€	909-DWECO870200	752€	909-DWECO680200	264€	909-DWECO5490200	264€



Codo 87°
con inspección (P1)



Codo 90°
con inspección (P1)



Terminal salida libre



Terminal salida cónica



Terminal anti-lluvia

Ø 80	909-DWECO67AL0080	290€	909-DWECO19AL0080	290€	909-DWECO320080	68€	909-DWECO32C0080	78€	909-DWECO5260080	91€
Ø 80 SCHWARZ	B09-DWECO67AL0080	378€	B09-DWECO19AL0080	378€	B09-DWECO320080	89€	B09-DWECO32C0080	102€	B09-DWECO5260080	119€
Ø 100	909-DWECO67AL0100	300€	909-DWECO19AL0100	300€	909-DWECO320100	70€	909-DWECO32C0100	80€	909-DWECO5260100	97€
Ø 100 SCHWARZ	B09-DWECO67AL0100	391€	B09-DWECO19AL0100	391€	B09-DWECO320100	90€	B09-DWECO32C0100	103€	B09-DWECO5260100	126€
Ø 130	909-DWECO67AL0130	309€	909-DWECO19AL0130	309€	909-DWECO320130	72€	909-DWECO32C0130	82€	909-DWECO5260130	100€
Ø 130 SCHWARZ	B09-DWECO67AL0130	402€	B09-DWECO19AL0130	402€	B09-DWECO320130	95€	B09-DWECO32C0130	107€	B09-DWECO5260130	129€
Ø 150	909-DWECO67AL0150	322€	909-DWECO19AL0150	322€	909-DWECO320150	82€	909-DWECO32C0150	91€	909-DWECO5260150	112€
Ø 150 SCHWARZ	B09-DWECO67AL0150	419€	B09-DWECO19AL0150	419€	B09-DWECO320150	107€	B09-DWECO32C0150	119€	B09-DWECO5260150	147€
Ø 180	909-DWECO67AL0180	376€	909-DWECO19AL0180	376€	909-DWECO320180	91€	909-DWECO32C0180	108€	909-DWECO5260180	129€
Ø 200	909-DWECO67AL0200	404€	909-DWECO19AL0200	404€	909-DWECO320200	110€	909-DWECO32C0200	125€	909-DWECO5260200	149€



Terminal anti-viento



Terminal horizontal con rejilla



Terminal Gas Light



Regulador de tiro



Estabilizador de tiro (adaptador + clapeta)

Ø 80	909-DWECO5270080	134€	909-DWECO5320080	86€	909-DWECO43500080	202€	909-DWECO5310080	216€	909-DWECO9700080	223€
Ø 80 SCHWARZ	B09-DWECO5270080	174€	B09-DWECO5320080	111€	B09-DWECO43500080	262€	B09-DWECO5310080	284€	B09-DWECO9700080	289€
Ø 100	909-DWECO5270100	140€	909-DWECO5320100	86€	909-DWECO43500100	215€	909-DWECO5310100	224€	909-DWECO9700100	235€
Ø 100 SCHWARZ	B09-DWECO5270100	183€	B09-DWECO5320100	11€	B09-DWECO43500100	280€	B09-DWECO5310100	290€	B09-DWECO9700100	307€
Ø 130	909-DWECO5270130	144€	909-DWECO5320130	88€	909-DWECO43500130	235€	909-DWECO5310130	230€	909-DWECO9700130	346€
Ø 130 SCHWARZ	B09-DWECO5270130	187€	B09-DWECO5320130	113€	B09-DWECO43500130	307€	B09-DWECO5310130	300€	B09-DWECO9700130	319€
Ø 150	909-DWECO5270150	158€	909-DWECO5320150	100€	909-DWECO43500150	265€	909-DWECO5310150	256€	909-DWECO9700150	315€
Ø 150 SCHWARZ	B09-DWECO5270150	205€	B09-DWECO5320150	129€	B09-DWECO43500150	346€	B09-DWECO5310150	333€	B09-DWECO9700150	409€
Ø 180	909-DWECO5270180	187€	909-DWECO5320180	117€	909-DWECO43500180	289€	909-DWECO5310180	301€	909-DWECO9700180	348€
Ø 200	909-DWECO5270200	216€	909-DWECO5320200	138€	909-DWECO43500200	322€	909-DWECO5310200	346€	909-DWECO9700200	366€



Adaptador simple a doble



Adaptador doble a simple



Soporte de carga regulable L=220 mm



Adaptador Hurricane



Placa base con desagüe lateral

Ø 80	909-DWECO370080	46,02€	909-DWECO37A0080	46,02€	909-DWECO3790080	186€	-	-	909-DWECO60080	204€
Ø 80 SCHWARZ	B09-DWECO370080	60€	B09-DWECO37A0080	60€	B09-DWECO3790080	243€	-	-	B09-DWECO60080	265€
Ø 100	909-DWECO370100	50€	909-DWECO37A0100	50€	909-DWECO3790100	193€	-	-	909-DWECO60100	215€
Ø 100 SCHWARZ	B09-DWECO370100	65€	B09-DWECO37A0100	65€	B09-DWECO3790100	250€	-	-	B09-DWECO60100	280€
Ø 130	909-DWECO370130	50€	909-DWECO37A0130	50€	909-DWECO3790130	197€	909-DWECO44760130	146€	909-DWECO60130	221€
Ø 130 SCHWARZ	B09-DWECO370130	65€	B09-DWECO37A0130	65€	B09-DWECO3790130	257€	-	-	B09-DWECO60130	288€
Ø 150	909-DWECO370150	59€	909-DWECO37A0150	59€	909-DWECO3790150	221€	909-DWECO44760150	170€	909-DWECO60150	248€
Ø 150 SCHWARZ	B09-DWECO370150	77€	B09-DWECO37A0150	77€	B09-DWECO3790150	288€	-	-	B09-DWECO60150	322€
Ø 180	909-DWECO370180	70€	909-DWECO37A0180	70€	909-DWECO3790180	259€	909-DWECO44760180	201€	909-DWECO60180	259€
Ø 200	909-DWECO370200	80€	909-DWECO37A0200	80€	909-DWECO3790200	299€	909-DWECO44760200	215€	909-DWECO60200	292€



Abrazadera de unión 1.0



Abrazadera para amarre con tornillo



Abrazadera fijación pared regulable 50-80 mm



Abrazadera de soporte



Abrazadera forjado inox

Ø 80	DW25450080	5,97€	DW2510630080	29,76€	DW255560080	34,25€	-	-	DW25620080	23,83€
Ø 80 SCHWARZ	O1-DW25450080	7,76€	O1-DW2510630080	38,69€	O1-DW255560080	44,53€	-	-	O1-DW25620080	30,98€
Ø 100	DW25450100	7,46€	DW2510630100	32,74€	DW255560100	35,73€	-	-	DW25620100	28,28€
Ø 100 SCHWARZ	O1-DW25450100	9,69€	O1-DW2510630100	42,56€	O1-DW255560100	46,45€	-	-	O1-DW25620100	36,75€
Ø 130	DW25450130	8,92€	DW2510630130	35,73€	DW255560130	35,73€	DW258580130	133€	DW25620130	38,82€
Ø 130 SCHWARZ	O1-DW25450130	11,60€	O1-DW2510630130	46,45€	O1-DW255560130	46,45€	O1-DW258580130	172€	O1-DW25620130	52€
Ø 150	DW25450150	10,42€	DW2510630150	38,82€	DW255560150	41,71€	DW258580150	133€	DW25620150	43,14€
Ø 150 SCHWARZ	O1-DW25450150	13,56€	O1-DW2510630150	50€	O1-DW255560150	55€	O1-DW258580150	172€	O1-DW25620150	56€
Ø 180	DW25450180	13,41€	DW2510630180	46,02€	DW255560180	47,47€	DW258580180	149€	DW25620180	46,02€
Ø 200	DW25450200	19,36€	DW2510630200	46,02€	DW255560200	55€	DW258580200	170€	DW25620200	46,02€



Sistema DW - ECO 1.0 316



Base de abrazadera distanciadora*



Alas distanciadoras A*



Alas distanciadoras B*



Alas distanciadoras C*



Alas distanciadoras D*

Ø 80	DW2514620080	41,71€					
Ø 100	DW2514620100	44,58€					
Ø 130	DW2514620130	47,47€					
Ø 150	DW2514620150	52€					
Ø 180	DW2514620180	71€					
Ø 200	DW2514620200	91€					
			665-ZUWA1462A	43,14€	665-ZUWA1462B	59€	
					665-ZUWA1462C	75€	
						665-ZUWA1462D	95€

i *Consultar página 215 para ver distancias de separación.



Soporte cubierta ventilado



Soporte de techo



Abrazadera fijación a techo



Abrazadera vientos



Abrazadera con doble pértiga telescópica

Ø 80	DW259340080	58€	DW259360080	31,25€	DW25118B0080	35,73€	DW25420080	10,42€	DW251910080	132€
Ø 100	DW259340100	61€	DW259360100	37,40€	DW25118B0100	38,82€	DW25420100	13,41€	DW251910100	134€
Ø 130	DW259340130	65€	DW259360130	46,02€	DW25118B0130	44,58€	DW25420130	19,36€	DW251910130	143€
Ø 150	DW259340150	72€	DW259360150	50€	DW25118B0150	53€	DW25420150	23,83€	DW251910150	158€
Ø 180	DW259340180	86€	DW259360180	59€	DW25118B0180	60€	DW25420180	25,32€	DW251910180	164€
Ø 200	DW259340200	98€	DW259360200	67€	DW25118B0900	60€	DW25420200	26,79€	DW251910200	179€

i *Necesario instalar collarín junto con el cubreaguas



Pasamuros



Cubreaguas plano inox



Cubreaguas plomo
0°- 5°



Cubreaguas plomo
5°- 25°



Cubreaguas plomo
25°- 45°

Ø 80	DW259870080	35,73€	DW2511280080	134€	DW259370080	187€	DW259380080	187€	DW259390080	328€
Ø 100	DW259870100	37,40€	DW2511280100	138€	DW259370100	188€	DW259380100	188€	DW259390100	332€
Ø 130	DW259870130	47,47€	DW2511280130	155€	DW259370130	214€	DW259380130	214€	DW259390130	347€
Ø 150	DW259870150	47,47€	DW2511280150	170€	DW259370150	238€	DW259380150	238€	DW259390150	353€
Ø 180	DW259870180	58€	DW2511280180	175€	DW259370180	246€	DW259380180	246€	DW259390180	363€
Ø 200	DW259870200	59€	DW2511280200	193€	DW259370200	269€	DW259380200	269€	DW259390200	367€

i *Necesario instalar collarín junto con el cubreaguas



Cubreaguas
5°-25° aluminio

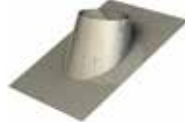

Cubreaguas
25° - 45° aluminio



Collarín antitormenta

i *Precio unidad. u/c= unidad caja



Junta de estanqueidad
(T<200°C)
u/c



Junta de condensación
(T<120°C)
u/c

∅ 80	DW25938AL0080	188€	DW25939AL0080	201€	DW253070080	26,79€	25	DW25260080	4,47€*	25	DW2526C0080	4,47€*
∅ 100	DW25938AL0100	197€	DW25939AL0100	213€	DW253070100	31,25€	25	DW25260100	4,47€*	25	DW2526C0100	4,47€*
∅ 130	DW25938AL0130	215€	DW25939AL0130	229€	DW253070130	37,40€	25	DW25260130	4,47€*	25	DW2526C0130	4,47€*
∅ 150	DW25938AL0150	231€	DW25939AL0150	246€	DW253070150	43,14€	25	DW25260150	4,47€*	25	DW2526C0150	4,47€*
∅ 180	DW25938AL0180	239€	DW25939AL0180	264€	DW253070180	47,47€	25	DW25260180	5,97€*	25	DW2526C0180	5,97€*
∅ 200	DW25938AL0200	258€	DW25939AL0200	279€	DW253070200	53€	25	DW25260200	7,46€*	25	DW2526C0200	7,46€*

ADAPTADOR CALDERA HEMBRA

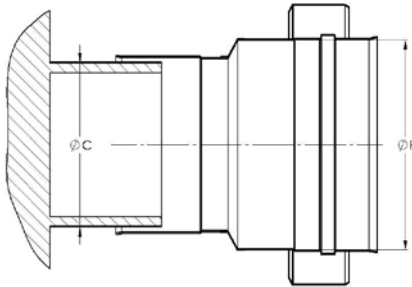

CÓDIGO	∅C CALDERA	∅F CHIMENEA	€
909-DWECO37H00800080	78 a 82	80	52€
909-DWECO37H00800100	78 a 82	100	80€
909-DWECO37H00800130	78 a 82	130	78€
909-DWECO37H01000080	98 a 102	80	82€
909-DWECO37H01000100	98 a 102	100	55€
909-DWECO37H01000130	98 a 102	130	80€
909-DWECO37H01000150	98 a 102	150	89€
909-DWECO37H01100080	108 a 112	80	82€
909-DWECO37H01100100	108 a 112	100	83€
909-DWECO37H01100130	108 a 112	130	80€
909-DWECO37H01100150	108 a 112	150	89€
909-DWECO37H01200080	118 a 122	80	83€
909-DWECO37H01200100	118 a 122	100	83€
909-DWECO37H01200130	118 a 122	130	80€
909-DWECO37H01200150	118 a 122	150	89€
909-DWECO37H01250080	123 a 127	80	83€
909-DWECO37H01250100	123 a 127	100	83€
909-DWECO37H01250130	123 a 127	130	55€
909-DWECO37H01250150	123 a 127	150	89€
909-DWECO37H01300080	128 a 132	80	83€
909-DWECO37H01300100	128 a 132	100	83€
909-DWECO37H01300130	128 a 132	130	55€
909-DWECO37H01300150	128 a 132	150	90€
909-DWECO37H01300180	128 a 132	180	111€
909-DWECO37H01350100	133 a 137	100	91€
909-DWECO37H01350130	133 a 137	130	55€
909-DWECO37H01350150	133 a 137	150	90€
909-DWECO37H01350180	133 a 137	180	111€

CÓDIGO	∅C CALDERA	∅F CHIMENEA	€
909-DWECO37H01400100	138 a 142	100	91€
909-DWECO37H01400130	138 a 142	130	89€
909-DWECO37H01400150	138 a 142	150	61€
909-DWECO37H01400180	138 a 142	180	112€
909-DWECO37H01500100	148 a 152	100	91€
909-DWECO37H01500130	148 a 152	130	89€
909-DWECO37H01500150	148 a 152	150	61€
909-DWECO37H01500180	148 a 152	180	112€
909-DWECO37H01500200	148 a 152	200	127€
909-DWECO37H01600130	158 a 162	130	100€
909-DWECO37H01600150	158 a 162	150	61€
909-DWECO37H01600180	158 a 162	180	112€
909-DWECO37H01600200	158 a 162	200	127€
909-DWECO37H01750130	173 a 177	130	100€
909-DWECO37H01750150	173 a 177	150	102€
909-DWECO37H01750180	173 a 177	180	75€
909-DWECO37H01750200	173 a 177	200	127€
909-DWECO37H01800130	178 a 182	130	100€
909-DWECO37H01800150	178 a 182	150	102€
909-DWECO37H01800180	178 a 182	180	75€
909-DWECO37H01800200	178 a 182	200	128€
909-DWECO37H02000150	198 a 202	150	112€
909-DWECO37H02000180	198 a 202	180	121€
909-DWECO37H02000200	198 a 202	200	86€
909-DWECO37H02250180	223 a 227	180	121€
909-DWECO37H02250200	223 a 227	200	134€
909-DWECO37H02500180	248 a 252	180	121€
909-DWECO37H02500200	248 a 252	200	134€



ADAPTADOR CALDERA MACHO

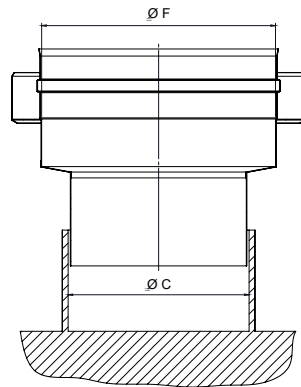

CÓDIGO	ØC CALDERA	ØF CHIMENEA	€
909-DWECO37M00800080	78 a 82	80	52€
909-DWECO37M00800100	78 a 82	100	80€
909-DWECO37M00800130	78 a 82	130	78€
909-DWECO37M01000080	98 a 102	80	82€
909-DWECO37M01000100	98 a 102	100	55€
909-DWECO37M01000130	98 a 102	130	80€
909-DWECO37M01000150	98 a 102	150	89€
909-DWECO37M01100080	108 a 112	80	82€
909-DWECO37M01100100	108 a 112	100	83€
909-DWECO37M01100130	108 a 112	130	80€
909-DWECO37M01100150	108 a 112	150	89€
909-DWECO37M01200080	118 a 122	80	83€
909-DWECO37M01200100	118 a 122	100	83€
909-DWECO37M01200130	118 a 122	130	80€
909-DWECO37M01200150	118 a 122	150	89€
909-DWECO37M01250080	123 a 127	80	83€
909-DWECO37M01250100	123 a 127	100	83€
909-DWECO37M01250130	123 a 127	130	55€
909-DWECO37M01250150	123 a 127	150	89€
909-DWECO37M01300080	128 a 132	80	83€
909-DWECO37M01300100	128 a 132	100	83€
909-DWECO37M01300130	128 a 132	130	55€
909-DWECO37M01300150	128 a 132	150	90€
909-DWECO37M01300180	128 a 132	180	111€
909-DWECO37M01350100	133 a 137	100	91€
909-DWECO37M01350130	133 a 137	130	55€
909-DWECO37M01350150	133 a 137	150	90€
909-DWECO37M01350180	133 a 137	180	111€

CÓDIGO	ØC CALDERA	ØF CHIMENEA	€
909-DWECO37M01400100	138 a 142	100	91€
909-DWECO37M01400130	138 a 142	130	89€
909-DWECO37M01400150	138 a 142	150	61€
909-DWECO37M01400180	138 a 142	180	112€
909-DWECO37M01500100	148 a 152	100	91€
909-DWECO37M01500130	148 a 152	130	89€
909-DWECO37M01500150	148 a 152	150	61€
909-DWECO37M01500180	148 a 152	180	112€
909-DWECO37M01500200	148 a 152	200	127€
909-DWECO37M01600130	158 a 162	130	100€
909-DWECO37M01600150	158 a 162	150	61€
909-DWECO37M01600180	158 a 162	180	112€
909-DWECO37M01600200	158 a 162	200	127€
909-DWECO37M01750130	173 a 177	130	100€
909-DWECO37M01750150	173 a 177	150	102€
909-DWECO37M01750180	173 a 177	180	75€
909-DWECO37M01750200	173 a 177	200	127€
909-DWECO37M01800130	178 a 182	130	100€
909-DWECO37M01800150	178 a 182	150	102€
909-DWECO37M01800180	178 a 182	180	75€
909-DWECO37M01800200	178 a 182	200	128€
909-DWECO37M02000150	198 a 202	150	112€
909-DWECO37M02000180	198 a 202	180	121€
909-DWECO37M02000200	198 a 202	200	86€
909-DWECO37M02250180	223 a 227	180	121€
909-DWECO37M02250200	223 a 227	200	134€
909-DWECO37M02500180	248 a 252	180	121€
909-DWECO37M02500200	248 a 252	200	134€

AMPLIACIONES

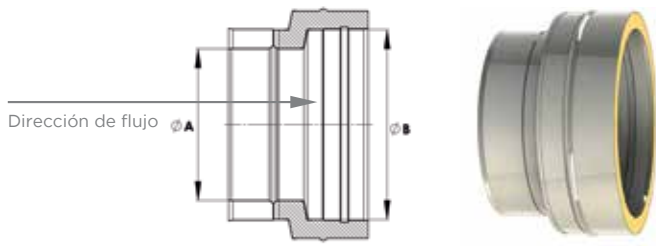

CÓDIGO	Ø A	Ø B	€
909-DWECOAX00800100	80	100	120 €
909-DWECOAX00800130	80	130	172 €
909-DWECOAX00800150	80	150	207 €
909-DWECOAX00800180	80	180	251 €
909-DWECOAX00800200	80	200	289 €
909-DWECOAX01000130	100	130	155 €
909-DWECOAX01000150	100	150	200 €
909-DWECOAX01000180	100	180	243 €
909-DWECOAX01000200	100	200	275 €
909-DWECOAX01300150	130	150	182 €
909-DWECOAX01300180	130	180	230 €
909-DWECOAX01300200	130	200	265 €
909-DWECOAX01500180	150	180	213 €
909-DWECOAX01500200	150	200	250 €
909-DWECOAX01800200	180	200	229 €

AMPLIACIONES EXCÉNTRICAS

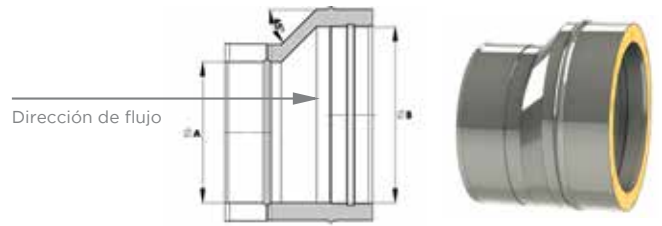

CÓDIGO	Ø A	Ø B	€
909-DWECORX00800100	80	100	155 €
909-DWECORX00800130	80	130	223 €
909-DWECORX00800150	80	150	270 €
909-DWECORX00800180	80	180	330 €
909-DWECORX00800200	80	200	375 €
909-DWECORX01000130	100	130	202 €
909-DWECORX01000150	100	150	259 €
909-DWECORX01000180	100	180	312 €
909-DWECORX01000200	100	200	357 €
909-DWECORX01300150	130	150	233 €
909-DWECORX01300180	130	180	301 €
909-DWECORX01300200	130	200	339 €
909-DWECORX01500180	150	180	273 €
909-DWECORX01500200	150	200	328 €
909-DWECORX01800200	180	200	299 €

REDUCCIONES

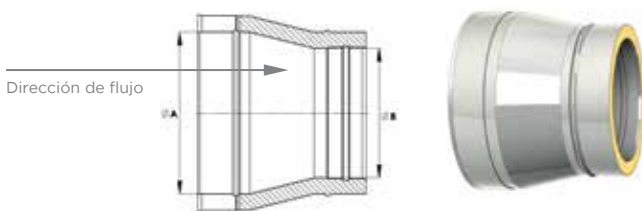

CÓDIGO	Ø A	Ø B	€
909-DWECOR01000080	100	80	120 €
909-DWECOR01300080	130	80	172 €
909-DWECOR01300100	130	100	155 €
909-DWECOR01500080	150	80	207 €
909-DWECOR01500100	150	100	200 €
909-DWECOR01500130	150	130	182 €
909-DWECOR01800080	180	80	251 €
909-DWECOR01800100	180	100	243 €
909-DWECOR01800130	180	130	230 €
909-DWECOR01800150	180	150	213 €
909-DWECOR02000080	200	80	289 €
909-DWECOR02000100	200	100	275 €
909-DWECOR02000130	200	130	265 €
909-DWECOR02000150	200	150	250 €
909-DWECOR02000180	200	180	229 €

REDUCCIONES EXCÉNTRICAS

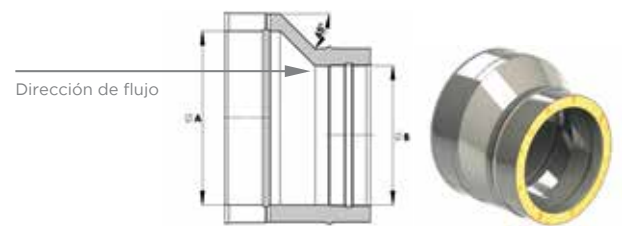

CÓDIGO	Ø A	Ø B	€
909-DWECORX01000080	100	80	155 €
909-DWECORX01300080	130	80	223 €
909-DWECORX01300100	130	100	202 €
909-DWECORX01500080	150	80	270 €
909-DWECORX01500100	150	100	259 €
909-DWECORX01500130	150	130	233 €
909-DWECORX01800080	180	80	330 €
909-DWECORX01800100	180	100	312 €
909-DWECORX01800130	180	130	301 €
909-DWECORX01800150	180	150	273 €
909-DWECORX02000080	200	80	375 €
909-DWECORX02000100	200	100	357 €
909-DWECORX02000130	200	130	339 €
909-DWECORX02000150	200	150	328 €
909-DWECORX02000180	200	180	299 €